



THE ITALIAN  
EDUCATION  
& RESEARCH  
NETWORK

# Relazione del Servizio IDEM GARR AAI

Davide Vagheti <[davide.vagheti@garr.it](mailto:davide.vagheti@garr.it)>

Assemblea dei Membri della Federazione IDEM  
2 Febbraio 2022



# IDEM Identity Provider e Service Provider

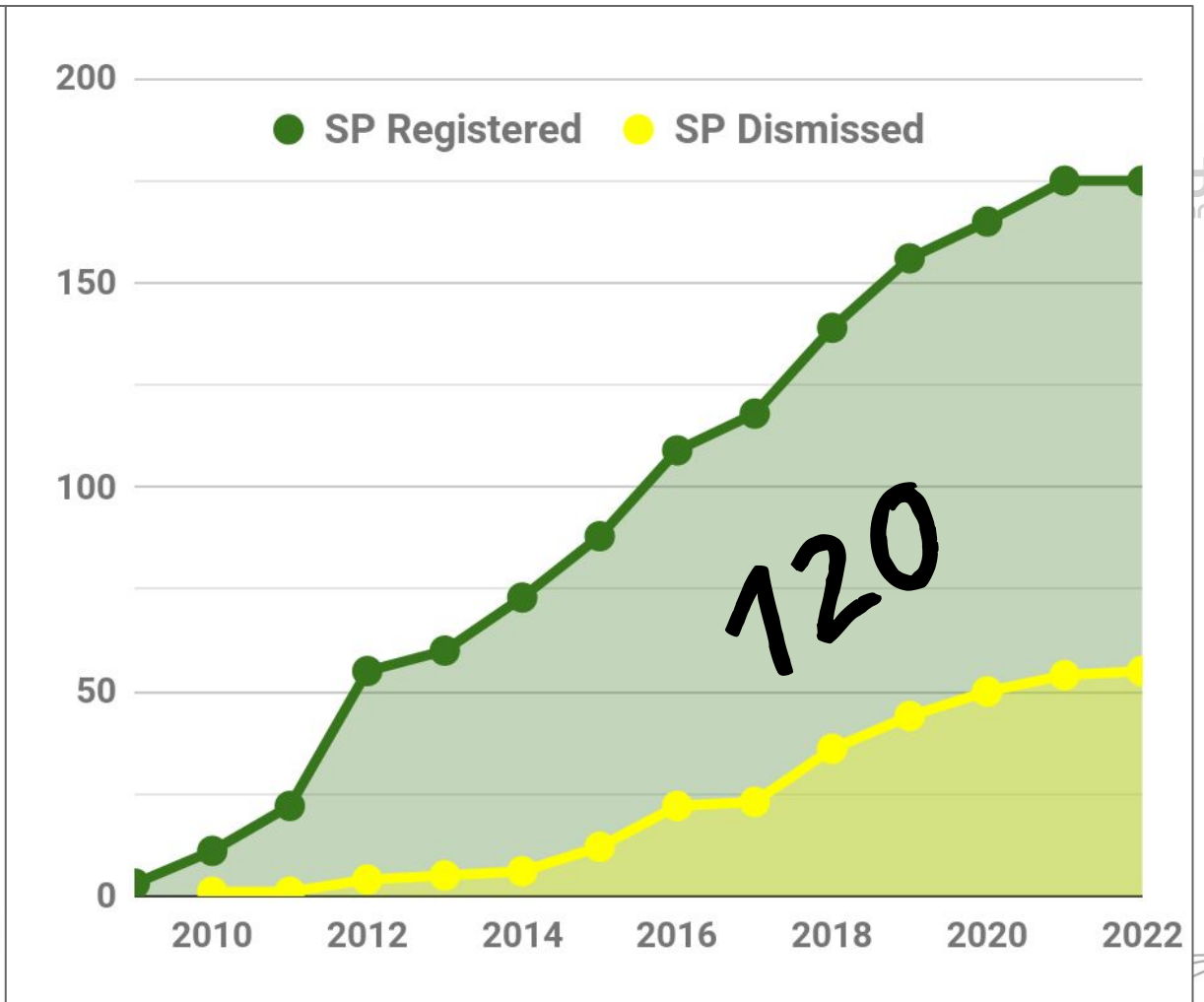
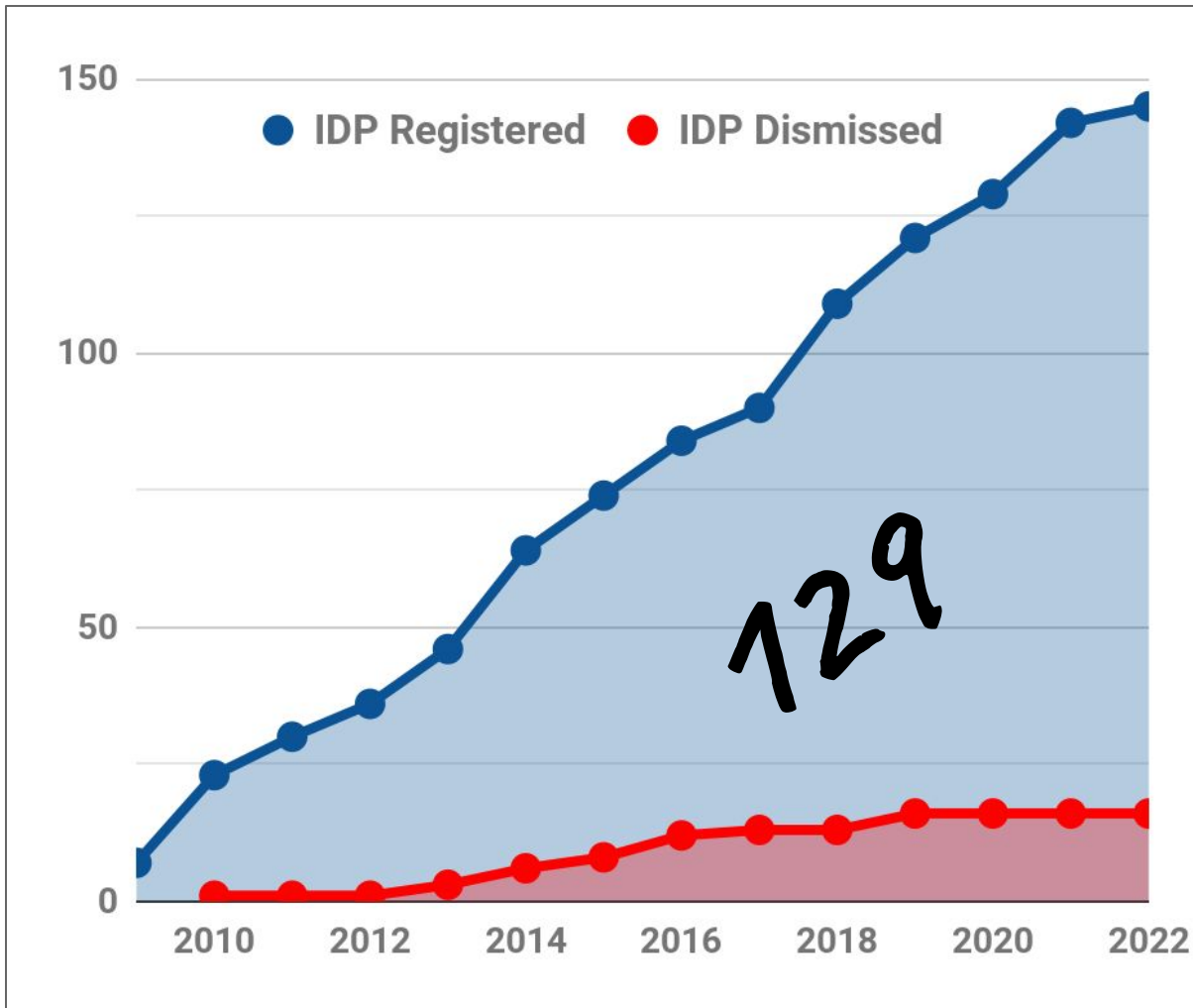

# Nuovi Membri IDEM 2021-2022

Università degli Studi di Enna "KORE"

Università degli Studi di TERAMO

Università degli Studi di Sassari

Università degli Studi della Basilicata

Università degli Studi di Foggia

Università della Valle d'Aosta

Luiss Guido Carli - Libera Università  
Internazionale degli Studi Sociali

Università Cattolica del Sacro Cuore

Scuola Normale Superiore

Università degli Studi "Gabriele d'Annunzio"

CISIA - Consorzio Interuniversitario Sistemi  
Integrati per l'Accesso

IRCCS MultiMedica - Milano

The Abdus Salam International Centre for  
Theoretical Physics

Archivio Centrale dello Stato

CRS4

Stazione Zoologica Anton Dohrn Napoli

# Nuovi Partner e Risorse IDEM 2021-2022

## Partner e Risorse

Bononia University Press

MediaLibraryOnLine - MLOL

INDIRE

Il Sole 24 Ore

Zanichelli Editore

AICUN - Associazione Italiana  
Comunicatori d'Università

Weschool

## Nuove Risorse

GARR Satosa Gateway (GARR)

IAM JUNO (INFN)

Collaborative Services (Politecnico di  
Milano)

UNIBO Service Gateway (Università  
di Bologna)

FORTHEM Unipa (Università di  
Palermo)

Alleanza FORTHEM (Università di  
Palermo)

# Popolazione e diffusione Atenei statali

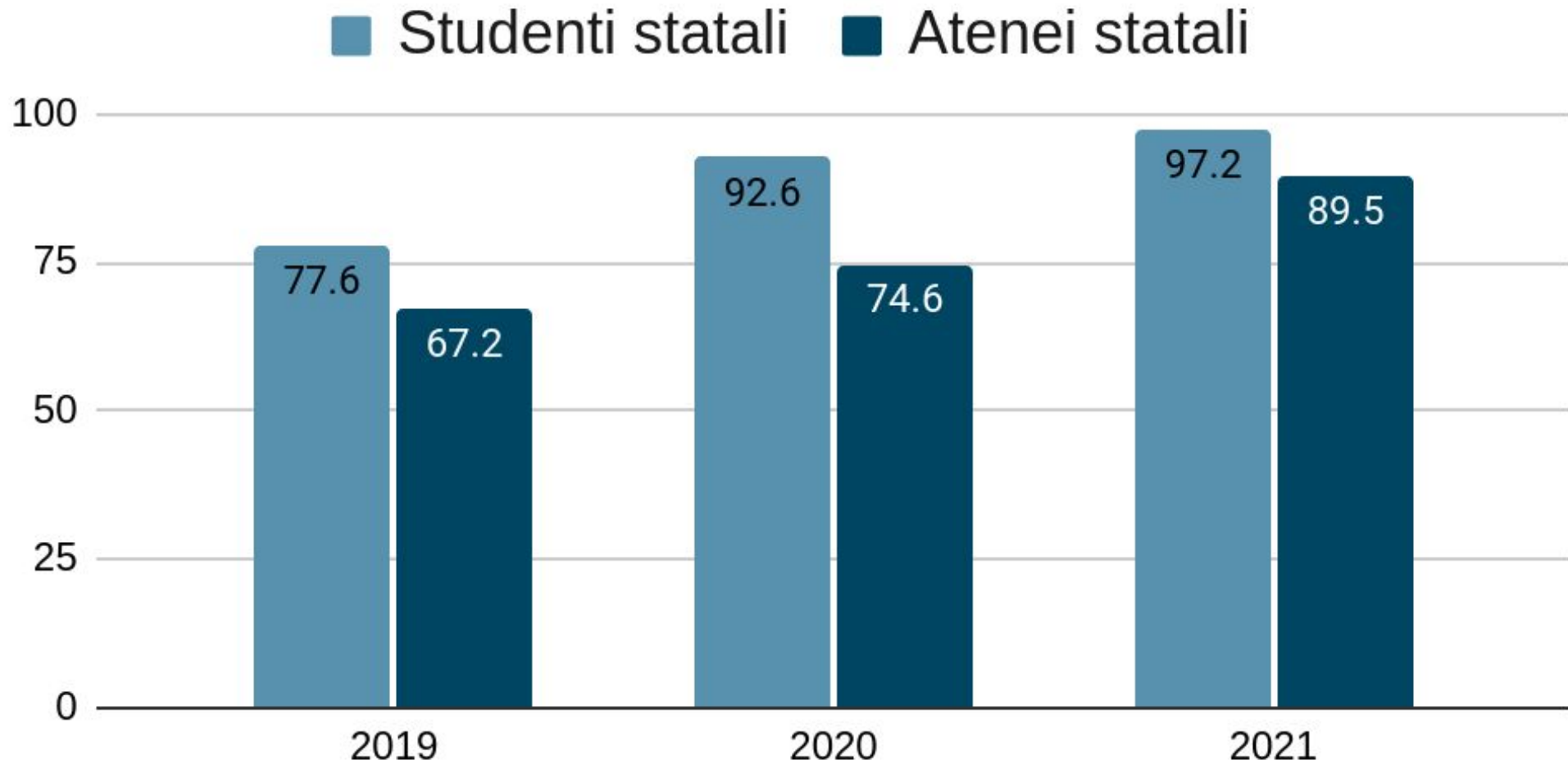

# Popolazione e diffusione Atenei italiani (statali e non)

Studenti 2021

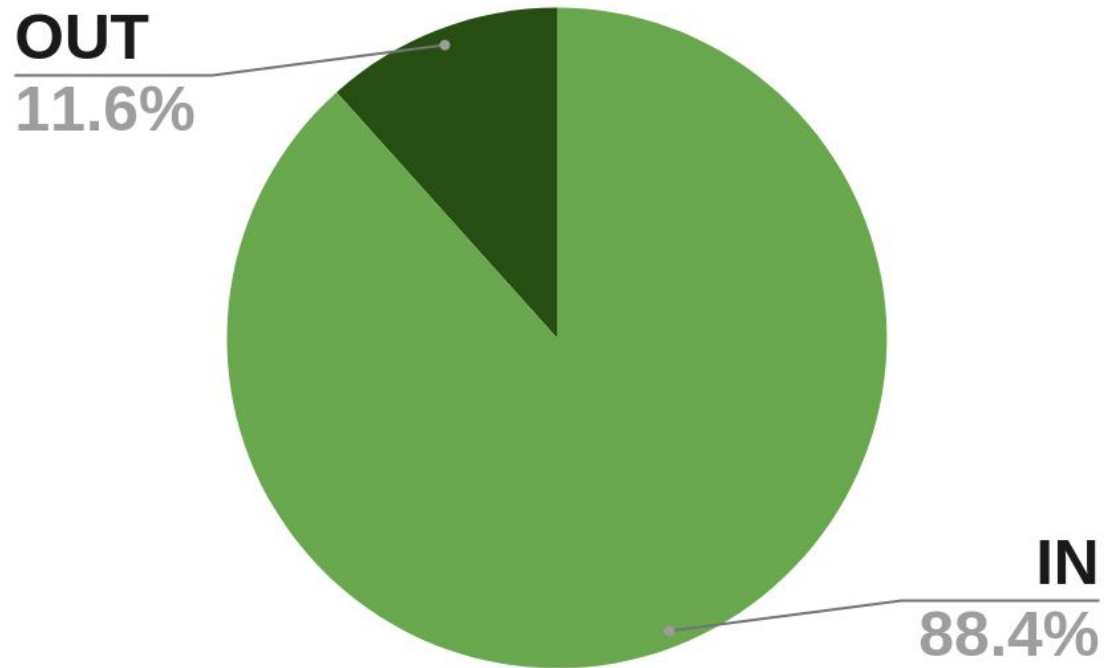

Atenei 2021

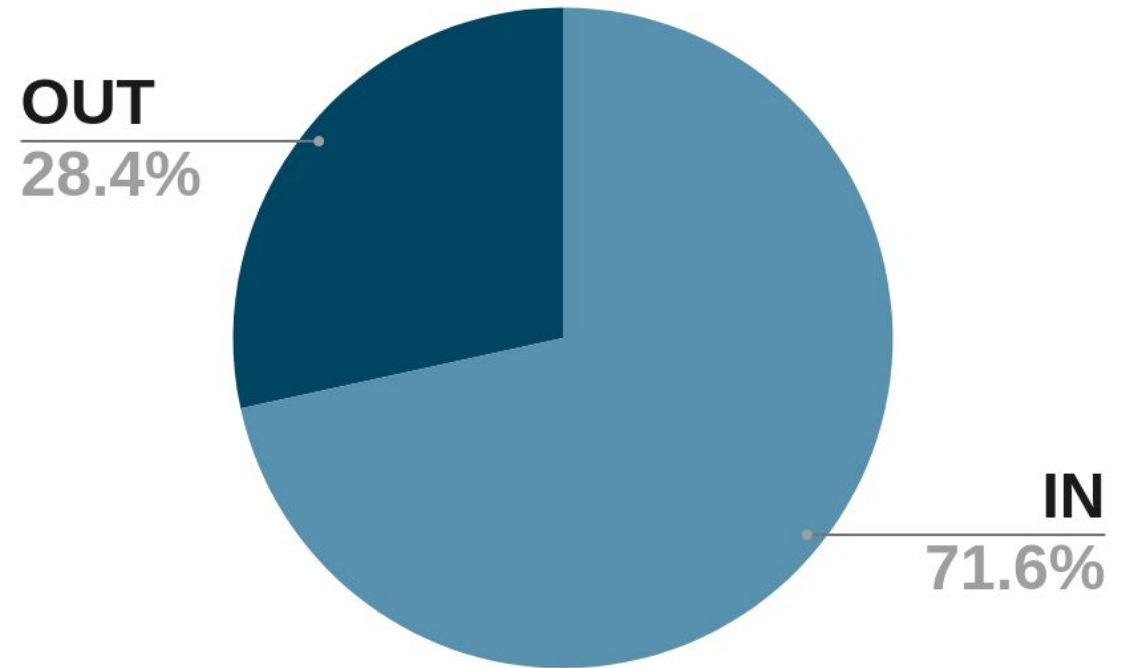



# eduGAIN

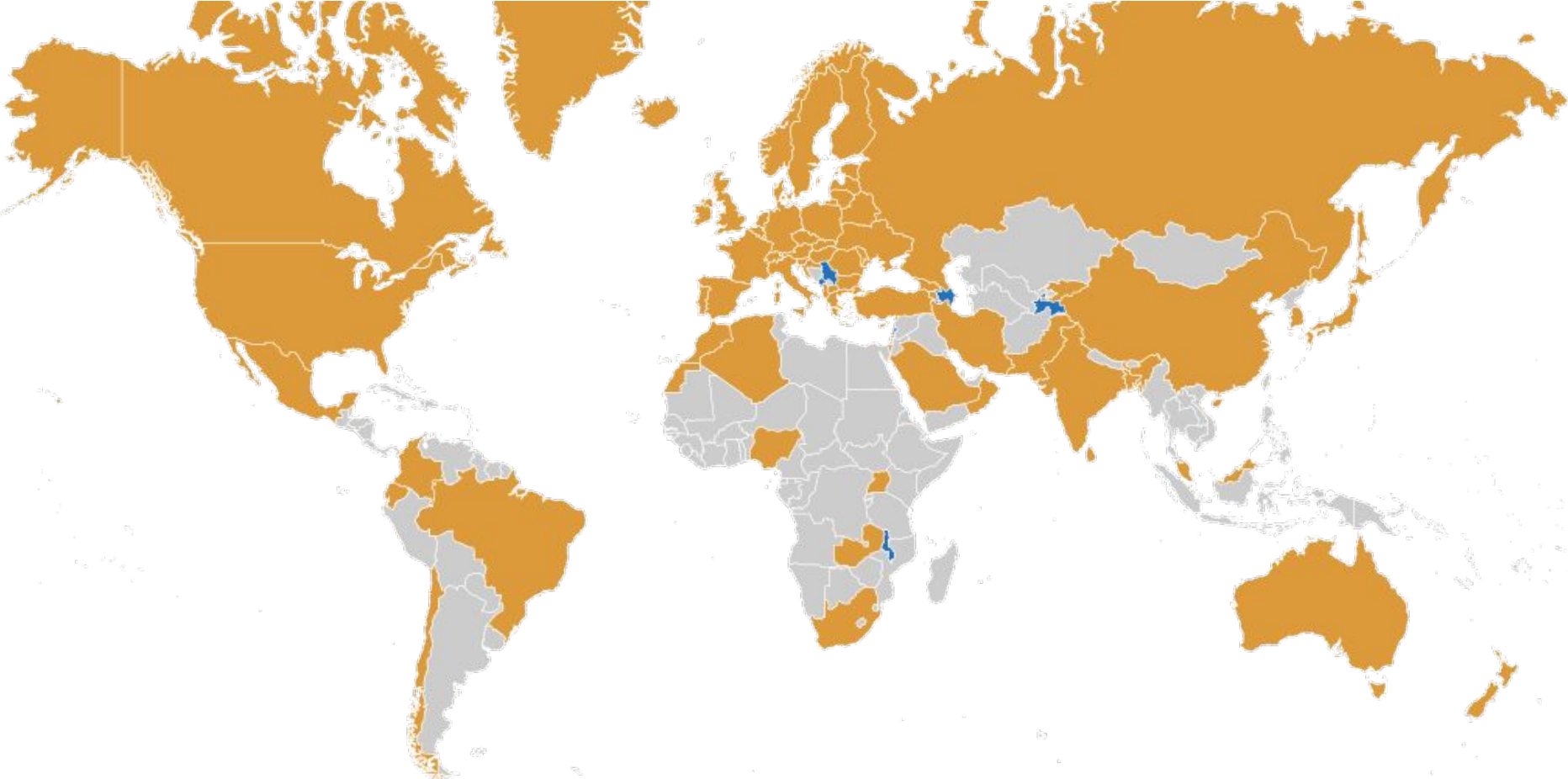

Federations in eduGAIN <span>?</span>	
Participants	74
Voting-only Members	1
Candidates	6
Entities in eduGAIN <span>?</span>	
All entities	8217
IdPs	4700
SPs	3525
Standalone AAs	3



**+ 11.6% Entities**  
**+ 12.6% IdPs**  
**+ 10.4% SPs**  
**+ 3 Federations**

Federations in eduGAIN	
Participants	74
Voting-only Members	1
Candidates	6
Entities in eduGAIN	
All entities	8217
IdPs	4700
SPs	3525
Standalone AAs	3



# Attività Servizio IDEM GARR AAI

# Attivazione accesso risorse editoriali



Chi devo contattare?



Quali dati devo fornire?



Quali attributi vanno rilasciati?

**Indice** [nascondi]

- 1 Editori attivi
  - 1.1 Faculty Opinions
  - 1.2 ASM Journals
  - 1.3 JAMA Network
  - 1.4 Sage
  - 1.5 MathWorks Edu
  - 1.6 La Mia Biblioteca, Edicola Professionale e One by Wolters Kluwer Italia
  - 1.7 [Digital loan for books by Zanichelli Editore](#)
  - 1.8 Scientific.net
  - 1.9 Mydesk24 per Crui - Il Sole 24 Ore
  - 1.10 American Physical Society
  - 1.11 Thomson Reuters (Westlaw Classic)
  - 1.12 Bononia University Press
  - 1.13 Sketch Engine
  - 1.14 PubMed.gov (National Center for Biotechnology Information)
  - 1.15 Bloomsbury Publishing (dramaonlinelibrary.com, www.bloomsburycollections.com)
  - 1.16 Wageningen Academic Publishers
  - 1.17 Mohr Siebeck
  - 1.18 The BMJ
  - 1.19 LOEB Classical Library
  - 1.20 ASME Digital Collection
  - 1.21 Kluwer Law Online Wolters Kluwer
  - 1.22 OpenAIRE
  - 1.23 Karger
  - 1.24 Science Direct
  - 1.25 Scopus
  - 1.26 Embase
  - 1.27 Mendeley

[https://wiki.idem.garr.it/wiki/Configurazioni Risorse Editoriali](https://wiki.idem.garr.it/wiki/Configurazioni_Risorse_Editoriali)

# European Student Identifier

Guida del Servizio: [https://wiki.idem.garr.it/wiki/Erasmus\\_Plus\\_e\\_ESI](https://wiki.idem.garr.it/wiki/Erasmus_Plus_e_ESI)

*The MyAcademicID Identity and Access Management Service provides Identity and Federated access management for the services of the [European Student Card Initiative](#) and the services directly supporting the digitisation of [Erasmus+](#). The MyAcademicID IAM Service is provided by [GÉANT](#) using the [eduTEAMS service](#).*

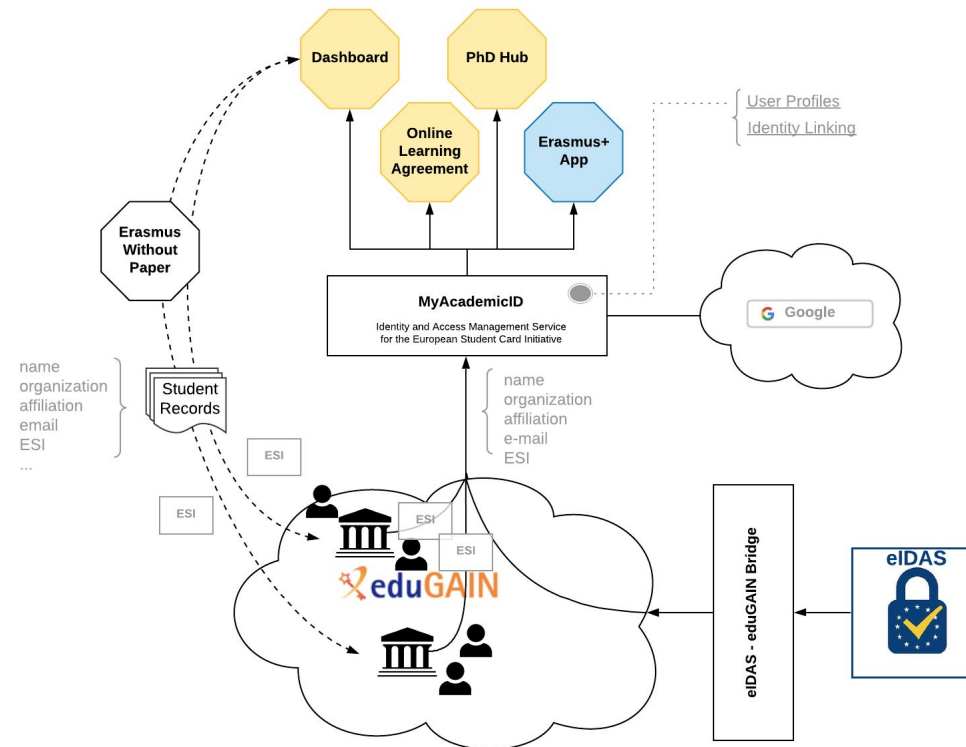

# IDEM MDQ

- Presentato al WS GARR 2021
- Lancio ufficiale fine Febbraio 2022
- In preparazione
  - Documentazione
  - Training

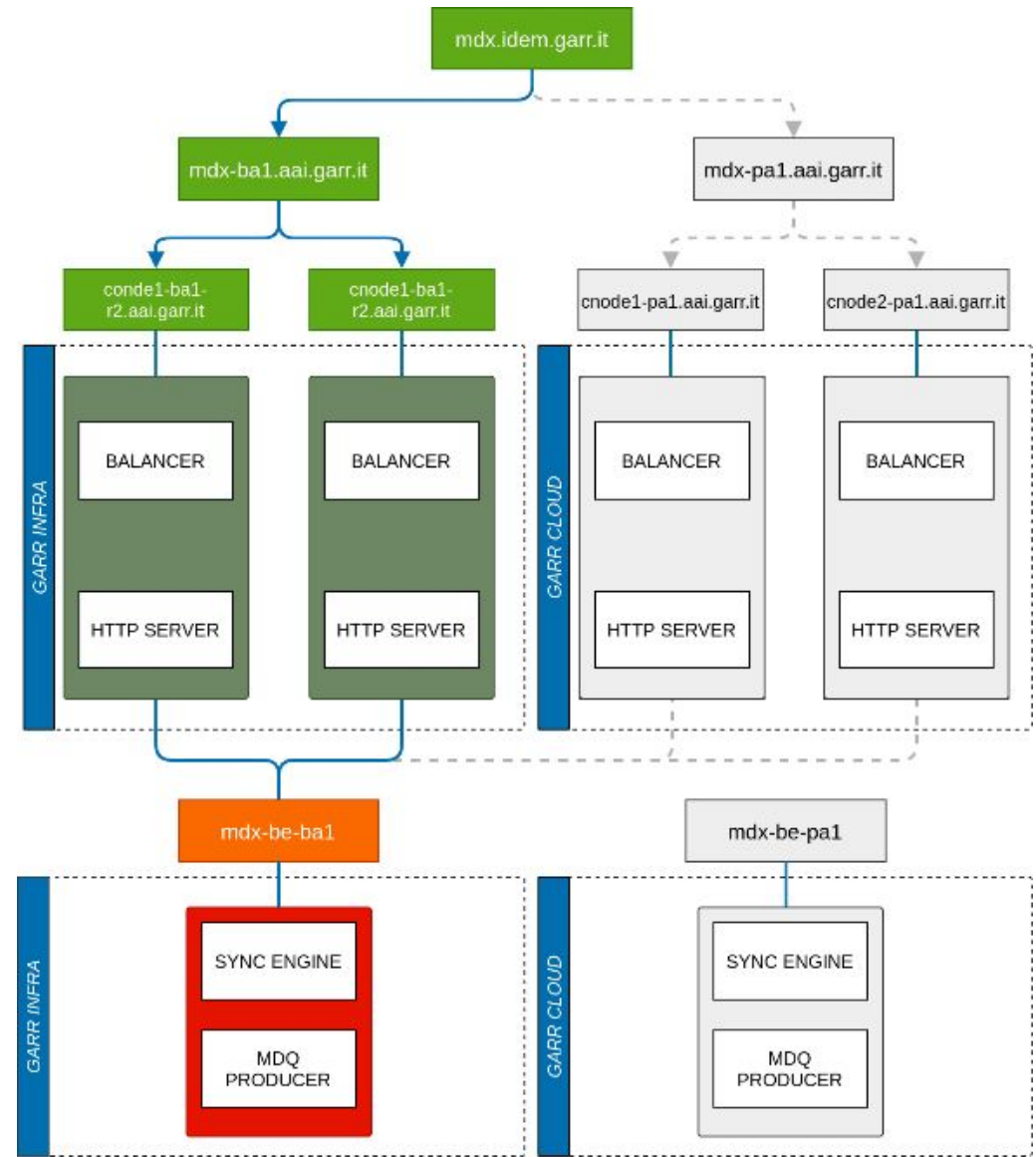

# F-Ticks per IDEM

- Basato su authentication event anonimi
- Raccolta statistiche centralizzata
- Architettura ELK
- Interfaccia pubblica
- Partecipazione a eduGAIN F-Ticks

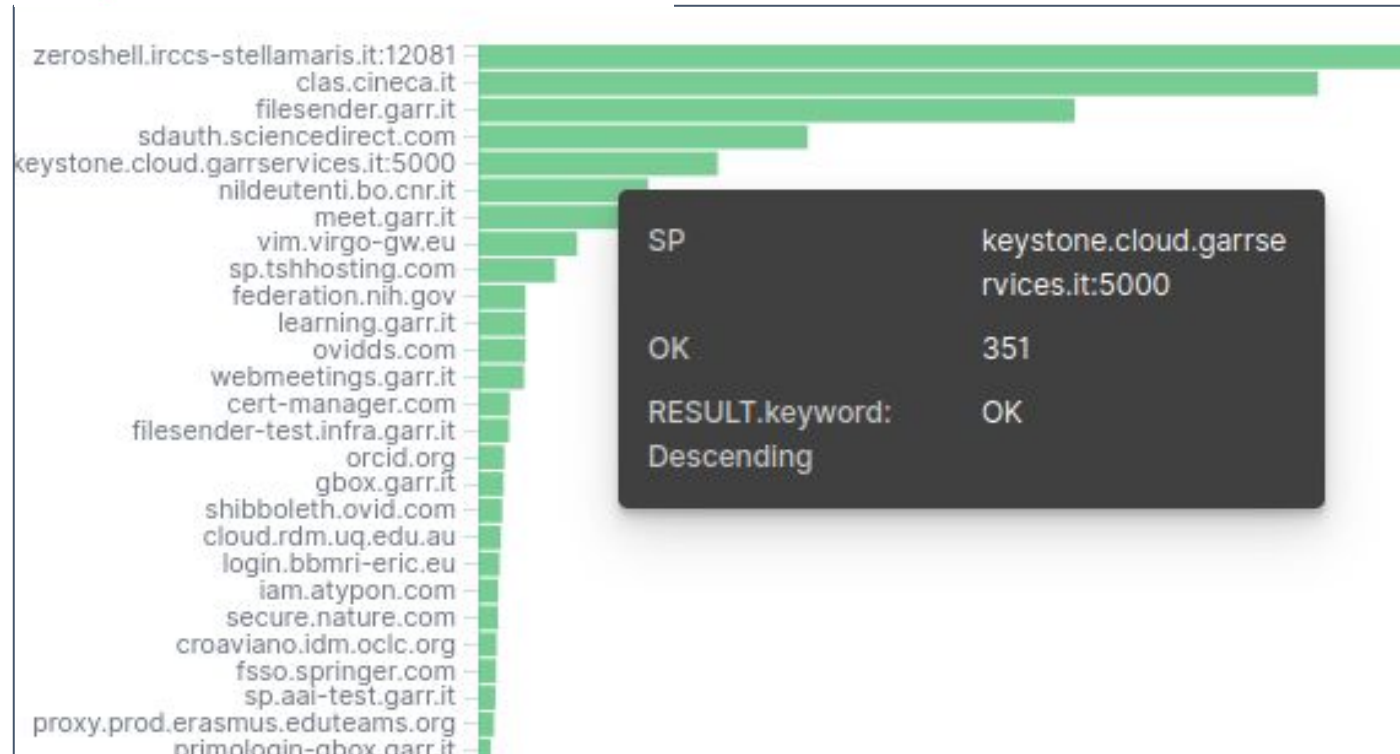



# The SheerID incident



## eduGAIN Security Team

Daniel Kouřil (CESNET)

Davide Vagheti (GARR)

Sven Gabriel (NIKHEF)

Romain Wartel (CERN)

# Agenda

- What happened (in case you missed)?
- What did we do?
  - The eduGAIN request
  - SheerID Response
  - eduGAIN Security Team

## Verify with your school

Sign up with your school to confirm your current enrollment.  
How does this work?



<https://www.university-name.edu>

Username \*



Password \*



I consent to share my account info with SheerID to prove my student status according to the [SheerID Privacy and Security Policy](#)

**Sign In**

Can't sign in to your school? [Upload proof instead](#)



Verification services powered by SheerID [SheerID FAQs](#)

## What happened?

- SheerID is a service provider that offers a service to verify the student status.
- On April 14th IDEM discovered that SheerID created a login page with the logo and the name of an Italian university.
- The credentials were used to effectively log into a university's portal, bypassing the federated authentication.
- The day after SheerID suspended the service globally.

# The eduGAIN request

On April 30 The eduGAIN leadership sent a notice to SheerID to express the concerns raised by the federation operators and to request:

- The list of all the institutions involved, federated or not.
- Starting date of the so called DSO system.
- Any data to assist in identifying authentication requests from SheerID's DSO.
- A full security incident debrief that explains exactly how the user credentials were acquired, stored, used and disposed.

To: Alex Boone (CTO SheerID), Greg Weinger (VP Product Management)  
Cc: Jim Kathman (VP Strategic Development), Neil Gabriel (VP Partnerships), David Shear (President)

Dear Alex and Greg,

We write to you in regards to the recent incident identified by the University of Trento, Italy on 14th April 2021. The incident was reported by the Italian Federation of Universities and Research Bodies for Authentication and Authorization (IDEM GARR AAI) to the International Research and Education Federation Operators Group shortly after. A similar incident has been also reported by the French Identity Federation (Fédération Éducation-Recherche). The incidents and the "SheerID Federation Community Response" dated 15th April 2021, have raised many concerns in the Research and Education Identity Federation Community and with the eduGAIN leadership team. We acknowledge SheerID's responsiveness in suspending this process on 15th April 2021.

We understand the verification process was intended for higher education institutions that are not part of a national federation but was inadvertently deployed to some federation participants (including the University of Trento). Whether the target is a federated institution or not, the international federation community has serious concerns about the process deployed. These are summarised as follows:

1. The use of official institution logos have occurred without obtaining authorization from their owners.
2. The process was established to look and feel like an official login page from an institution, misleading the users - a process commonly associated with phishing.
3. The process asked students to share their institutional username and password with SheerID systems. In most cases this places the student in breach of the institution's Acceptable Use Policy for those credentials and may be considered a data breach.
4. The process has not followed the European General Data Protection Regulation and was deployed without any formal agreement between the institutions as Data Controllers of the student's personal information and SheerID as the Data Processor of such information.
5. The process was deployed to institutions that are members of National Research and Education Federations for which there are existing, secure alternatives.
6. The solution harvests credentials and is considered as a phishing or man-in-the-middle attack by information security professionals. The approach diminishes SheerID's credibility. Holding these credentials in clear text, even if temporarily, exposes SheerID to significant risk should this system become compromised.

A number of concerns however are still being discussed in the community.

The process in question brings many concerns about SheerID values and mission and until this matter is resolved, several Federation Operators are considering blocking the SheerID Service Provider from eduGAIN. IDEM GARR AAI, SWAMID and Fédération Éducation-Recherche have already started doing that.

# SheerID's response

On May 11 SheerID shared the requested information for the affected federated entities and the DSO system:

- It has been in use for 4 months.
- It covered 23 Identity Federations.
- It has been set up for 159 Organisations.

On June 3 and June 10 SheerID sent the remaining information for non federated entities:

- 37 Countries.
- 427 Organisation.

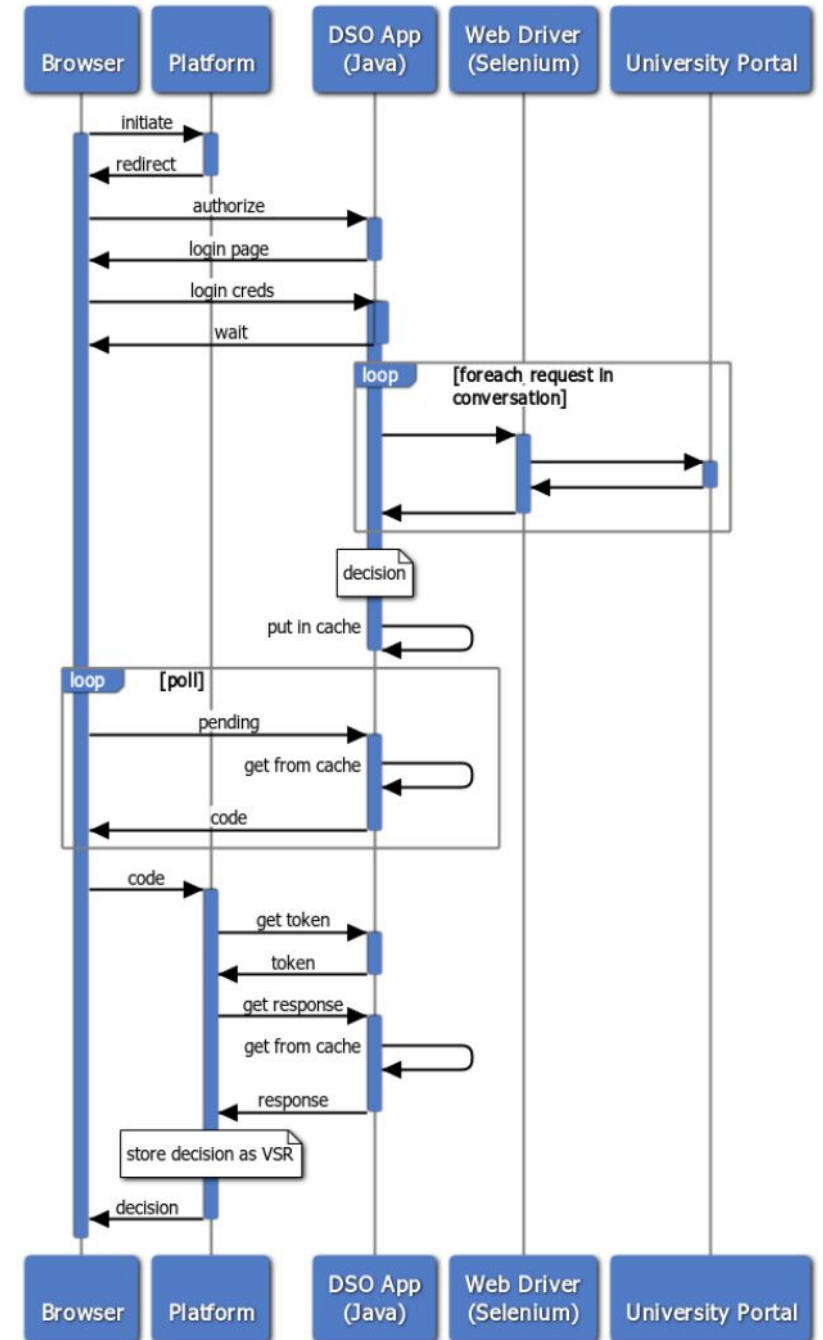



# eduGAIN Security Team

Security incident communication workflow.

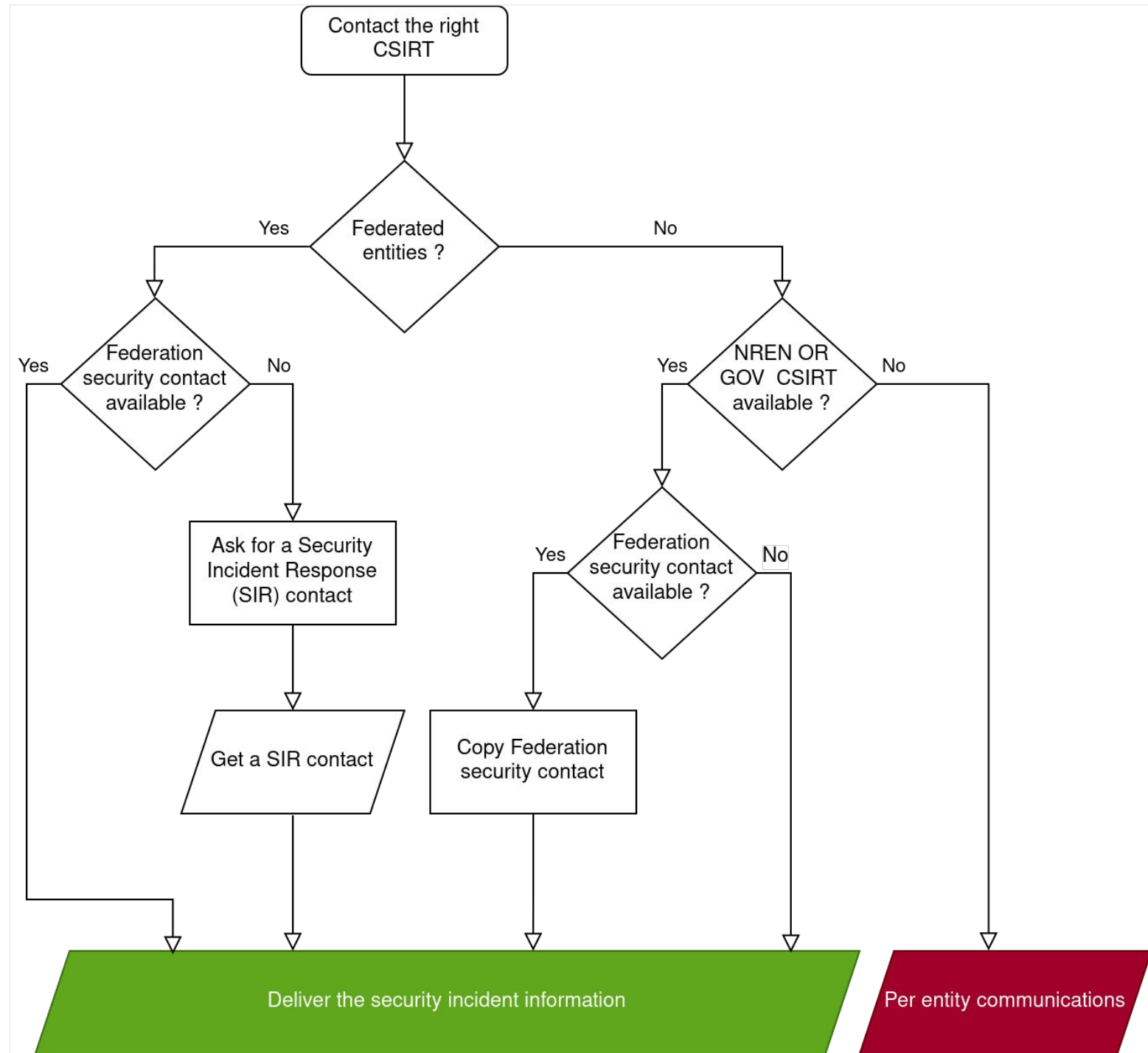

# InAcademia

# Student verification services

- soggetti commerciali
- servizi di scontistica
- importati da eduGAIN "as is"
- nessun supporto lato IDEM
- privacy e trasparenza?
- ampiamente utilizzati in IDEM



Bloomberg

Back  
Market



Clarivate™



codecademy

# Service Provider eduGAIN in IDEM

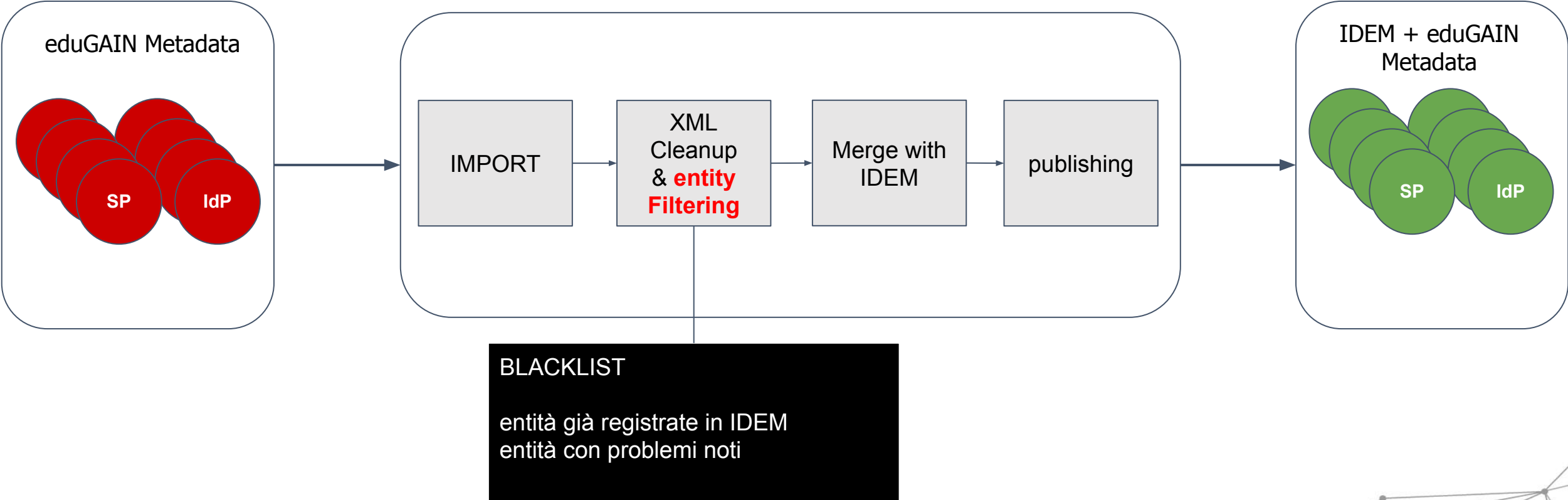

# Service Provider IDEM e eduGAIN a confronto

## Rilascio attributi

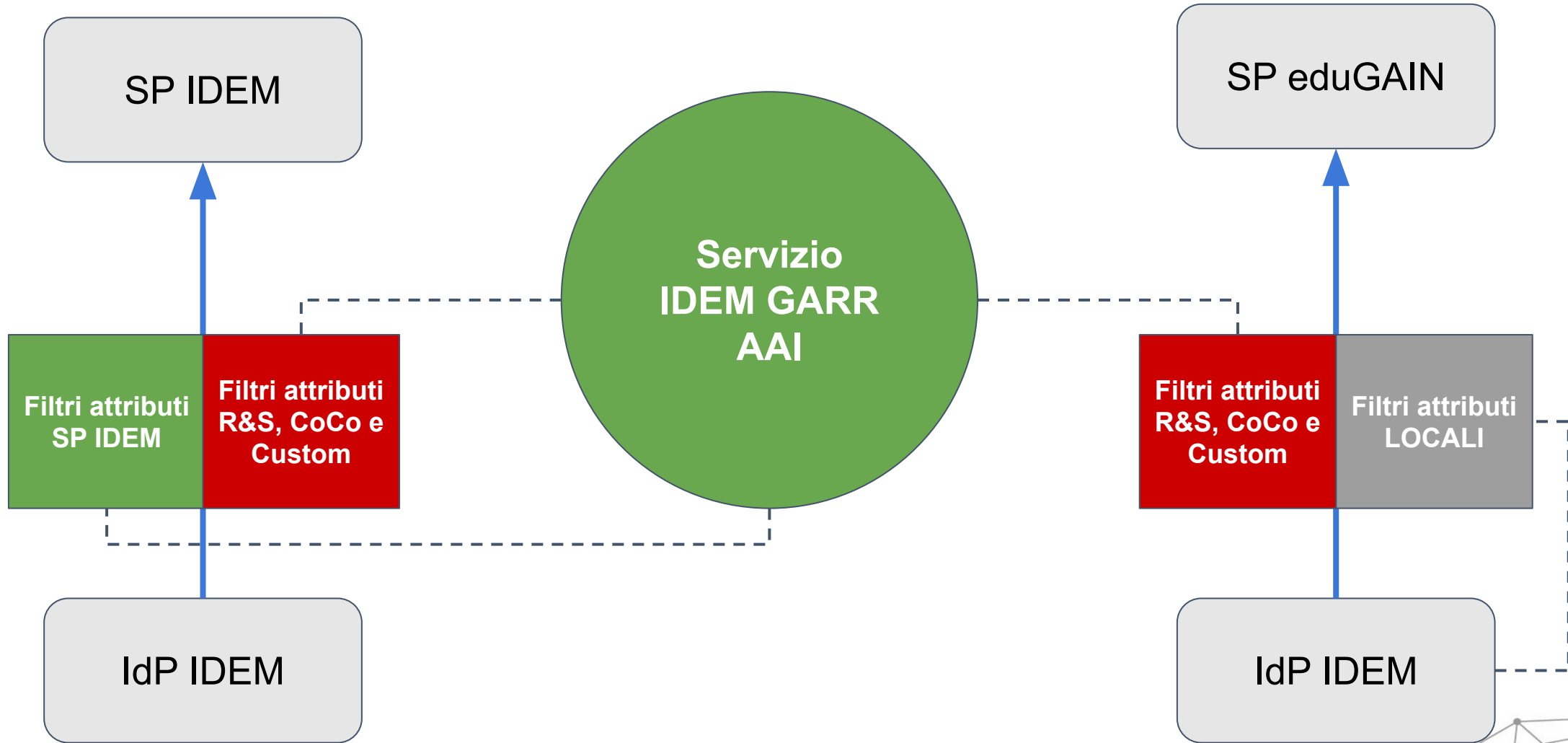



*InAcademia benefits Identity Federations, IdPs, Users and Merchants...*



Provides a lighter-weight alternative to Federation membership



A service of universal appeal across federations in eduGAIN



Minimises the release of users' personal data to 3rd parties

*...to reduce support effort and enhance privacy*



## Who



Commercial services  
(using Fed IDs for profit)

Not-for-profit SPs that don't  
need (or can't justify) full  
federation membership

NREN/Federation operator can  
propose national use cases

## Where



Only merchants in  
EU/GÉANT Membership  
countries

If federation operator is  
actively supportive of  
InAcademia (e.g. policy and/or  
promotion)

## How



Idp\_hinting allows us to  
ensure merchants use  
InAcademia only where  
permitted

# InAcademia Flow

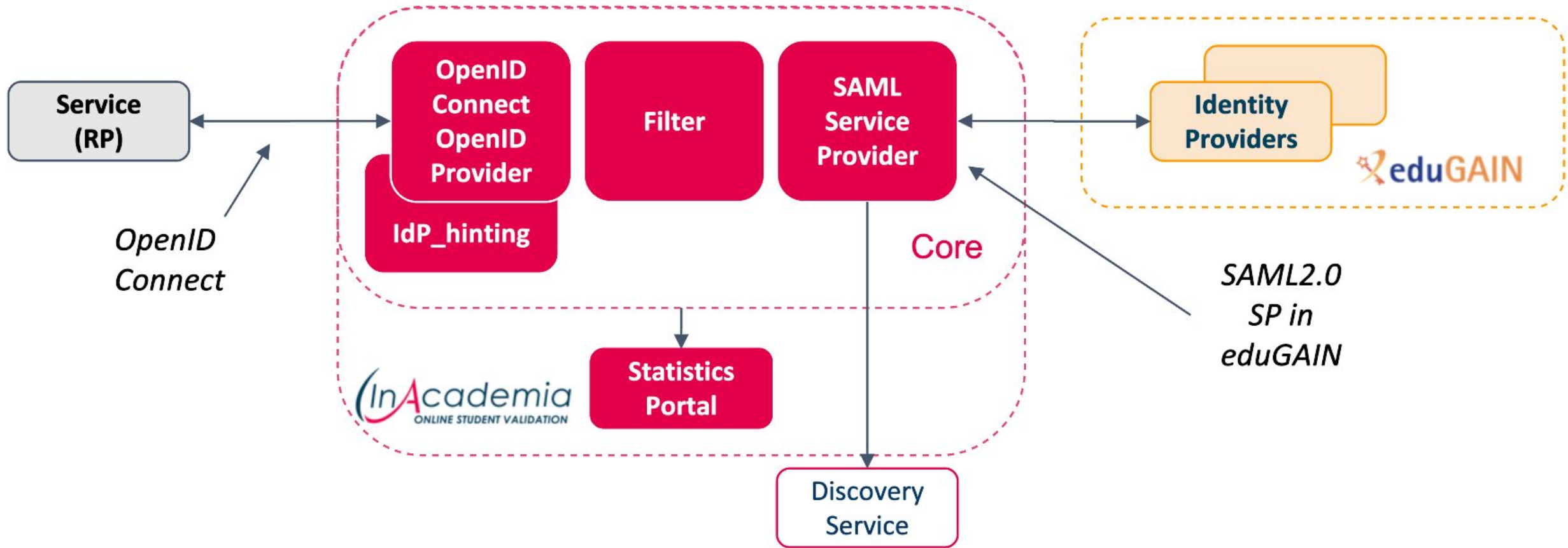



# InAcademia partecipanti e governance



## *InAcademia Constitution*

### *2. Governance and Governing Bodies*

#### *2.1 InAcademia Steering Committee*

*[...] Its members are:*

- The InAcademia Service Owner*
- A minimum of **five nominated representatives of Participating Federations** that actively support the outreach activities to their constituents, represent the best interests of R&E Identity Federations in the InAcademia service and have no conflict of interest. The number of representatives should be an odd number that enables effective steering and voting.*
- An Executive representative of the Service Operator.*



THE ITALIAN  
EDUCATION  
& RESEARCH  
NETWORK

# Grazie

Daide Vagheti <[davide.vagheti@garr.it](mailto:davide.vagheti@garr.it)>

